

## 1. General

### 1. Scope OUTDOOR OFC-DW-(Twisted), SM (0.9) LOOSE TUBE BLACK

This specification covers the construction and properties of optical fiber three tubes stranded, dry core fiber optic cable for aerial application. Optical fibers are in compliance with ITU-T Recommendation G.652.D.

### 2. Quality Assurance

FURUKAWA takes pride in being an industry leader recognized for producing a quality product. To ensure a continuing level of quality in production cables, consistent quality systems with ISO 9001 "Quality Management System", and ISO 14001 "Environment Management System" are provided for all optical fiber and fiber optic cables.

The adequacy of all materials is assured through incoming inspection, source inspection, or vendor certified data. Fiber is measured and classified before being placed into inventory, and then selected from inventory to satisfy customer order requirements. Inspection of cable construction characteristics is the responsibility of the employees producing the product. All cables are tested for compliance to customer specified transmission requirements in Final Test. Adequacy of this quality control system is assured through product and process audits conducted by the internal quality improvement organization.

FURUKAWA is supported by standards such as

- Electronic Industries Association (EIA)
- Telecommunications Industry Association (TIA)
- International Telecommunications Union (ITU)
- International Electrotechnical Commission (IEC)
- American Society for Testing and Materials (ASTM)
- TIS 2166-2548 (2005) Optical fiber cables Part 3-20 : Outdoor cables- Family specification for optical self-supporting aerial telecommunication cables

All of optical fiber cable element should comply with RoHS Directive 2002/95/EC and its amendment directives with the Laboratory that fully comply with the requirements of ISO/IEC 17025-05, The Basic Rules, IEC 01: 2008-11 and Rules of Procedure IEC 02: 2008-10, and the relevant IEC CB-Scheme Operational Documents

### 1.3 General Fiber Optic Cable Characteristics

High quality optical fibers made with pure silica-based glass have very low loss for infrared wavelengths and can be used to carry large amounts of information for very long distances in optical communication systems. High fiber strength is obtained by protecting the surface of the glass fiber with thin coating layers of polymeric materials.

The coated fibers are then placed in cable structures having additional layers to protect the fiber during the rigors of outside plant installation and to provide long term reliable operation in the outside plant environment. The design philosophy in meeting these objectives is to provide high quality, rugged, well-tested fiber optic cables, which are compact and have a high strength-to-weight ratio. Compact fiber optic cables are easier to handle and install in the field and provide longer length for field installation.

## 2. Optical Fiber Requirements

FURUKAWA Zero Water Peak (ZWP) Single Mode Optical Fiber consists of a germanium doped core and a silica cladding. The fiber is fully compatible with other commercially available matched cladding fibers. FURUKAWA ZWP Single Mode Optical Fiber is the industry's first fiber designed for use with transmission systems operating in entire wavelength region from 1280 to 1625 nm. Current systems operate in either the 2<sup>nd</sup> window (1280-1325 nm) or the 3<sup>rd</sup> window (1530-1565 nm). The 5<sup>th</sup> window from 1350 to 1450 nm has not been available because of higher attenuation (up to 1 dB/km) over much of the region. FURUKAWA ZWP fiber enables usage over this much wider range because of a new manufacturing process, which practically eliminates the incorporation of OH ions (water) into the fiber. A concentration of several parts per billion (ppb) of OH ions in a conventional single mode fiber core cause the attenuation in the region around 1385 nm (the "water" peak) to be up to 300% higher than in the 1310 nm region. With FURUKAWA ZWP fiber, the attenuation in the 5<sup>th</sup> window is always less than that in the 2<sup>nd</sup> window.

FURUKAWA Fibers feature a dual UV curable acrylate coating system, which provides unparalleled performance in a wide range of environmental conditions. The advantages of this coating structure are excellent resistance to micro-bending induced losses, superior hydrolytic stability and long term preservations of color code integrity. The coating is easily strippable using mechanical methods.

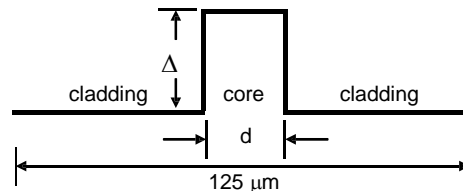

(d = core diameter)

Fig.1 Refractive index profile, Dispersion Unshifted Single Mode Fiber

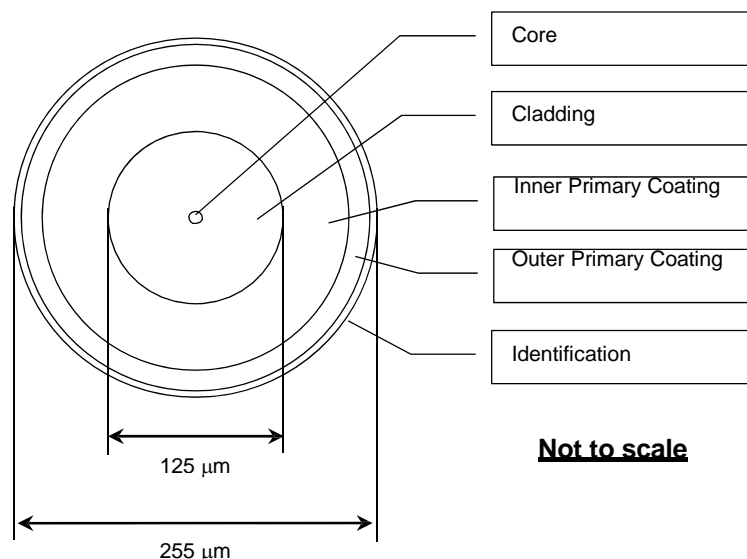

Fig. 2 Cross Section View of Dispersion Unshifted Single Mode Fiber

Table 1. Dispersion-Unshifted, Single Mode Fiber Requirements (ITU-T Rec. G.652.D)

Fiber attributes	
Item	Description
Manufacturing Method	VAD (vapor axial deposition method)
Refractive Index Profile	Step Index, Matched Cladding
Core	Germania (GeO <sub>2</sub> ) doped Silica (SiO <sub>2</sub> )
Core Diameter	8.3 μm
Cladding	Silica (SiO <sub>2</sub> )
Primary Coating	2 layers of UV curable resin
Index of refraction Difference	0.36%
Group refractive index *	1.469 @ 1310 nm and 1550 nm
Cladding Diameter	125 ± 1 μm
Cladding Non-Circularity	≤ 1 %
Core/Cladding Concentricity error	≤ 0.5 μm
Coating Diameter (uncolored)	245 ± 5 μm
Coating/Cladding Concentricity error	≤ 12 μm
Colored Fiber Diameter	255 ± 10 μm
Mode Field Diameter	9.2 ± 0.4 μm @ 1310 nm 10.4 ± 0.6 μm @ 1550 nm
Proof test stress	The entire length of fiber is subjected to tensile stress greater than 0.69 GPa.
Attenuation with Bending	100 turns, 30 mm radius ≤ 0.10 dB @ 1550 nm
Zero-Dispersion Wavelength (λ <sub>0</sub> )	1300 ≤ λ <sub>0</sub> ≤ 1324 nm
Zero-Dispersion Slope	≤ 0.092 ps/(nm <sup>2</sup> .km)
Chromatic dispersion coefficient, D(λ)	$D(\lambda) = \lambda S_{0max} / 4 \cdot [1 - \{\lambda_0 / \lambda\}^4]$ ps/(nm.km) (λ = Operating Wavelength) ≤ 3.5 ps/(nm.km) @ 1288 ~ 1339 nm ≤ 18 ps/(nm.km) @ 1550 nm
Coating Strip Force (@ 0 °C to +45 °C)	1.3 N (0.3 lbf) ≤ F ≤ 8.9 N (2.0 lbf)
Numerical Aperture	0.13 ± 0.01
Cable attributes	
Item	Description
Attenuation	Max. 0.36 dB/km, Typ. 0.34 dB/km @ 1310 nm Max. 0.36 dB/km, Typ. 0.32 dB/km @ 1383 nm Max. 0.25 dB/km, Typ. 0.21 dB/km @ 1550 nm Max. 0.35 dB/km, Typ. 0.24 dB/km @ 1625 nm
Cabled Cut-off Wavelength (λ <sub>cc</sub> )	≤ 1260 nm
Polarization mode dispersion (PMD)	≤ 0.20 ps/√km

Optical time domain reflectometers (OTDRs) require the setting of the fiber's group refractive index in order to calculate and display distance. The above is a group refractive index values for OTDR settings.

3. Cable Characteristics and Construction

Table 2. Construction of optical fiber three loose tubes stranded, dry core aerial fiber optic cable.

Item		Description				
		2 Fibers	4 Fibers	6 Fibers	8 Fibers	12 Fibers
Optical Fiber	Construction	Table 1				
Filling Compound	Material	Thixotropic Jelly Compound				
Loose Tube	Material	(PBT) Polybutylene Terephthalate with color code				
	Fiber per Tube	2	4	6	4	6
	Number	1	1	1	2	2
Filler Rod	Material	Plastic rod, natural color				
	Number	2	2	2	1	1
CSM	Material	Reinforcement & Water Blocking Material				
Stranding	Method	Reverse oscillating lay (ROL) technique (SZ Direction)				
Water Blocking Element	Material	Suitable Water Swellable Materials (Dry-Core Technology)				
Core Covering	Material	Water Blocking Tape				
	Assembly	The tape shall be wrapped longitudinally over the cable core				
Ripcord	Material	Polyester cord				
Sheath	Material	UV-Proof Black High Density Polyethylene				
	Thickness	Nominal 1.5 mm				
Messenger Wire	Material	Extra High Strength Galvanized Steel Wire				
	Diameter	Nominal 1.6 mm				
Cable Diameter (Approx.) mm.		8.0				
Overall Diameter (Approx.) mm.		13.0				
Cable Weight (Approx.) kg/km		75				
Structure		Fig. 3				

Note:

- The thickness of the thinnest point shall not be measured at the groove of the ripcord.
- Manufacturer may use additional suitable tape(s), thread(s) or dielectric elements into suitable place in the cable for manufacturer's reason.

2 Fibers

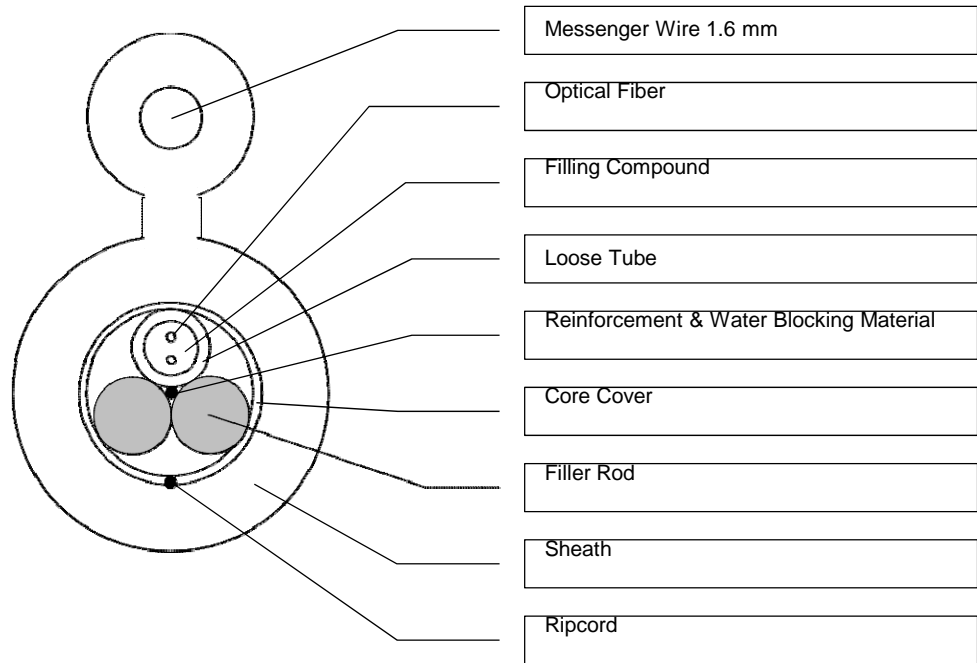

4 Fibers

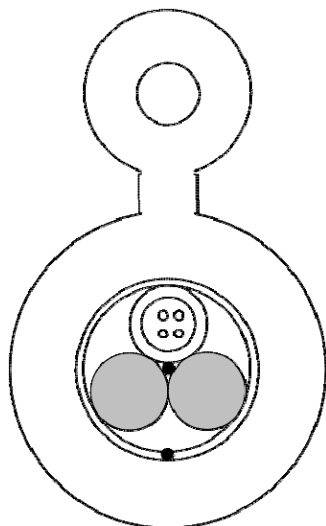

6 Fibers

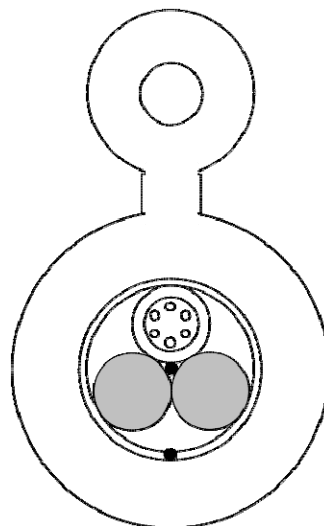
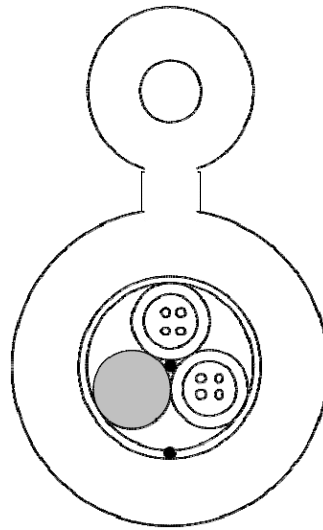
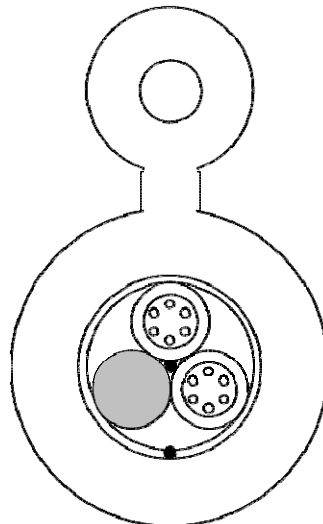

Fig. 3-1 Cross-section view of optical fiber three loose tubes stranded, dry core aerial fiber optic cable.

8 Fibers



12 Fibers



**Not to scale**

Fig. 3-2 Cross-section view of optical fiber three loose tubes stranded, dry core aerial fiber optic cable.

Table 3 EIA/TIA-598A Color Code for Fiber and Loose tube Identification

No.	Fiber Identification	Loose Tube Identification
1	Blue	Blue
2	Orange	Orange
3	Green	-
4	Brown	-
5	Slate	-
6	White	-

Note: - All fibers and tube used in our cables are color code to facilitate individual identification. Unless otherwise specified, all cables employ the standard industry color code system in accordance with the Munsell color shades as specified in EIA/TIA-359. And EIA/TIA-598A, Color Coding of Fiber Optic Cables. Anyway, the color code can be changed by customer's request.

- Unless otherwise requested by the customer, all cable jackets are black.

Table 4. Mechanical Specification of the cable

Item		Specification
Maximum Allowable Pulling Tension/Operation		1,350/600 N
Maximum pole span length		40 m
Initial Sag		0.5% of span length
Maximum Wind Velocity		Max. 100 km/hr
Installation/Operation Temperature		- 40°C to + 70°C
Storage/Shipping Temperature		- 40°C to + 75°C
Minimum Bending Radius	During Installation Or handling	15 x External Diameter of Cable
	During Service Or fixed	10 x External Diameter of Cable

Note: The maximum allowable pulling tension is the greatest pulling force that can be applied to a cable during installation without cable damage.

4. Mechanical and Environmental Test Requirements.

This section covers the mechanical and environmental test for the cable.

Table 5 Mechanical, Environmental Test Requirements for the cables

Item	Spec	Method
Torsion Test (Twist Test)	Maximum attenuation change $\leq 0.10$ dB at 1550nm. There shall be no cracking, splitting, or similar damage of the cable exterior.	TIA/EIA-455-85A or IEC-60794-1-2-E7 Test sample; 1 m Maximum Load; per table 2, EIA-455-85A Rotation; $\pm 180$ degree, 10 cycles
Tensile Performance Test	Maximum attenuation change $\leq 0.05$ dB at 1550 nm at 1,100 N	IEC-60794-1-2-E1 Test sample; 25m Minimum Sheave Dia.; 480mm (Universal) Load; 1,100 N
Impact Test	Maximum attenuation change $\leq 0.10$ dB at 1550 nm.	TIA/EIA-455-25B or IEC-60794-1-2-E4 Starting Energy; depend on cable diameter, per Table 1 EIA/TIA-455-25B Number Impact; 20 Test sample; Approx. 20 m
Repeated Bending Test (Flexing Test)	Maximum attenuation change $\leq 0.10$ dB at 1550 nm. There shall be no cracking, splitting, or similar damage of the cable exterior.	TIA/EIA-455-104A or IEC-60794-1-2-E6 Sheave Dia.; 20 x cable dia. Number Cycles ; 25 Load; per Table 2, EIA-455-104A Test Sample ; Approx. 20 m
Compression Test	Maximum attenuation change $\leq 0.10$ dB at 1550 nm. There shall be no cracking, splitting, or similar damage of the cable exterior.	TIA/EIA-455-41A or IEC-60794-1-2-E3 Load ; 2,200N (220N/cm) Duration; 10 minutes Test sample ; Approx. 20 m
Cable Bending Test	Maximum attenuation change $\leq 0.10$ dB at 1550 nm. There shall be no cracking, splitting, or similar damage of the cable exterior.	IEC-794-1-E11B Mandrel Diameter: 20 x cable dia. Cycles : 1
Water Penetration Test	No fluid leaks through the open cable end after 1 hour.	EIA-455-82B or IEC-60794-1-2-F5 Fluid Pressure; 1m static head or equivalent pressure. Test sample ; 3 m Duration ; 1 hour
Temperature Cycling Test	Max. Attenuation change $\leq 0.10$ dB/km at 1550 nm at operating temp. There shall be no cracking, splitting, or similar damage of the cable exterior.	TIA/EIA-455-3A or IEC-60794-1-2-F1 Time at Temp. ; Table of EIA/TIA-455-3A. Temp. Range ; -40°C ( $\pm 2^\circ$ C) Minimum +70°C ( $\pm 2^\circ$ C) Maximum Number of Cycles; Not less than 1 cycle



5. Cable Marking and Shipping Requirements

1. Sheath marking

The sheath marking is available upon customer's request. The sheath marking shall be printed (Hot Stamp) on the outer sheath of the cable with white color in one-meter intervals.

2. Reels

1. The cable will be delivered at the required length on a wooden reel. The reels are designed to prevent damage to the cable during shipment and installation.
2. The cable shall be delivered on wooden reel in standard manufacturing length of 4,000 m. (Special length is available upon request, but the cost may be increased.)
3. The diameter of the barrel shall be not less than 30 times of the outer diameter of the cable.
4. Circumference shall be completely enclosed with wooden battens, these battens shall be secured by nails to each flange. There are metallic bands are strapped about the wooden batten to help secure the battens to the reel.
5. To provide access for testing, the inner end of the cable protrudes through the inside of the reel. The end is securely kept on the side of the flange to protect it during transport and storage. The length of the inner end is typically 1 meter. The cable ends are securely fastened so as not to protrude beyond any portion of the reel in an unprotected manner and to prevent the cable from becoming loose in transport.

3. Sealing and Cable Termination

The both end of the cable shall be sealed with a suitable rubber cap or heat shrinkable cap to prevent ingress of moisture.

4. Information Accompanying the Reel

The following information is securely attached to the reel.

- |  |                |
|--|----------------|
| - Manufacturer's Name                  | - Drum No.     |
| - Customer's Name                      | - Reel ID.     |
| - Customer Order Number                | - Ship Length  |
| - Customer Part Number (if Applicable) | - Gross Weight |
| - Kind & Size (Cable Description)      | - Net Weight   |
| - Order Length                         | - Date         |
| - Outside sequential                   |                |
| - Inside sequential                    |                |

**- END OF SPECIFICATION -**